

Data Sheet



Article number: 0121077

Description: Retaining ring JL 62X2
Spring steel

Measures

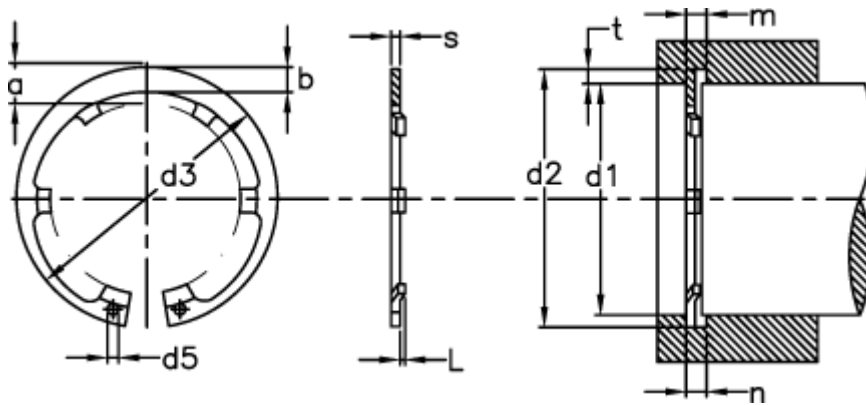

a max	= 8.2	FL max kN	= 1.47	s	= 2.00
b	= 5.6	FN kN	= 49.8	tol	= 0.30
C kN/mm	= 2.67	FRg kN	= 13.00	tol	= +1,10 -0,46
d1	= 62	FR kN	= 60.90	u	= 0.10
d2	= 65.0	g	= 2.0		
d3	= 66.2	L min	= 0.65		
d5 min	= 2.5	m min	= 2.15		
Description	= AL 62	Nominal drive	= 4.5		